

Data sheet

LED Downlight SDR-079/20W



Product

Model name	SDR-079
Maker	Stardust LED
Voltage	AC 85V~265V (50 / 60 Hz)
Power Consumption	20W
Driver	Include
Product	LED Downlight

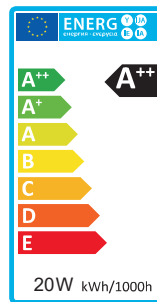

Dimensional drawing (unit:mm)

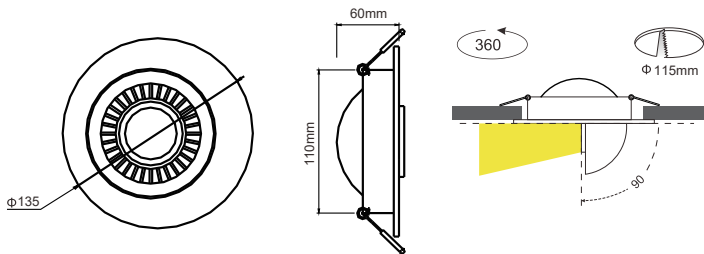

Through the unique structural design, it can be rotated 360° and retracted by 50°, which is convenient for irradiation, and the CRI can be selected as 80/90. The room temperature is optional (2700K/3000K/4000K/5000K), which increases the illumination range of the lamp and is more convenient to use.

The LED recessed spots are presented in a simple design. The built-in spots are pleasantly modern and discreet. LED recessed spotlights are light sources that can be used universally and can be installed in the living room, office, bedroom, kitchen, hallway or stairwell.



Lighting Data

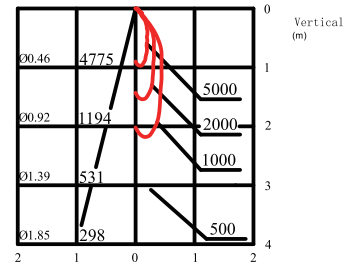
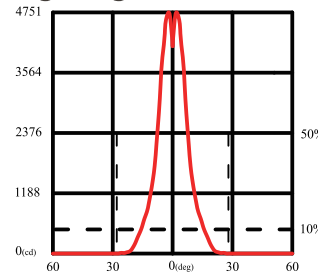

SDR-079(20W,3000k,26deg)
Specifications

SDR-079(20W,3000k,26deg)

Model name	SDR-079
Nominal luminous flux(lm)	1800 -1900lm
Frequency(Hz)	50/60Hz
Input current(mA)	Max. 600mA
Nominal power consumption(W)	20W
Power factor	>0.9
Lumen maintenance factor	L70
Dimmable function	Non-Dimmable / Dimmable
Nominal beam angle(°)	26°
Operating temperature(°C)	-20°C~+48°C
Nominal lamp life time(hrs)	50000hrs
Color temperature(K)	2700K~5000K
CRI(Ra)	>80Ra
Rating	IP 44
Dimension(mm)	Φ 135X60mm
Material	Aluminium
Weight(KG)	0.62KG
Energy efficiency index	A++
Energy consumption(kWh/1000h)	20 kWh/1000h
Certification	CE

Application

- Retail shop, apartment, living room, home, kitchen hallway and stairwell



LED Downlight SDR-079/20W

Beam Angle

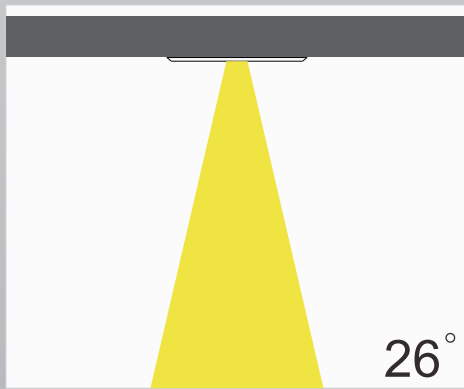

Contact

Stardust Lighting Co.,Ltd

+86-757-82226490

+86-757-86408550

postmaster@stardust-lighting.com

www.stardust-lighting.com

Cross of Shangbo, Nanhai Luocun Town, Foshan
China 528226



Installation Instruction

1. Drill a right hole where need to install downlight. Trun off the powerswitch, connect operating voltage.

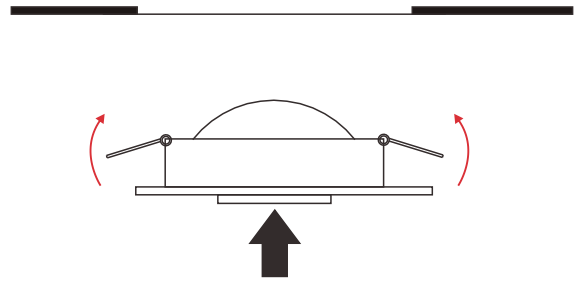

2. Put up spring dump before installing the downlight.

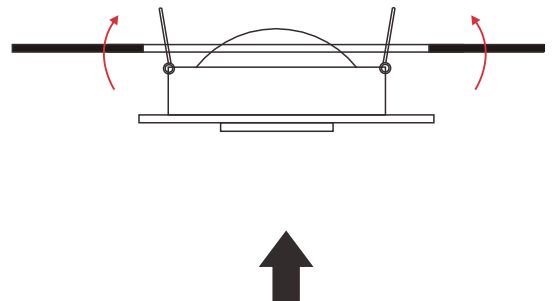

3. Insert the LED downlight to the hole like the picture schows.

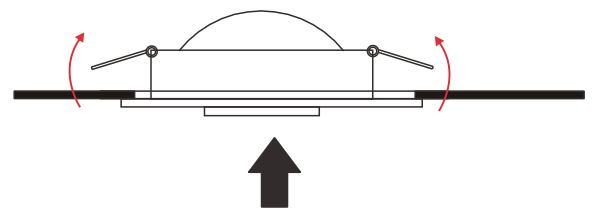

4. Completed the installation.

