

Data sheet

LED Image Projector SDG-001



Product

Model name	SDG-006
Maker	Stardust LED
Voltage	AC 85V~265V (50 / 60 Hz)
Power Consumption	30W
Driver	Include
Product	LED Image Projector

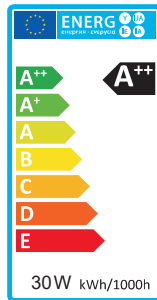

Lighting Data

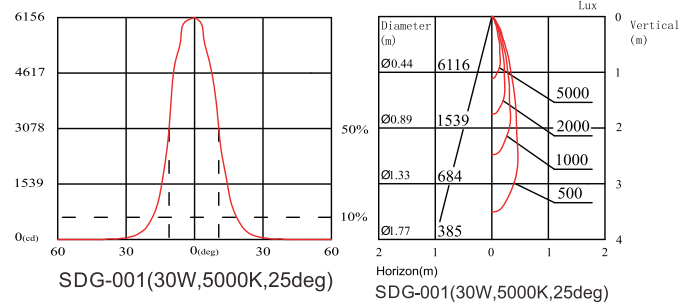

Specifications

Model name	SDG-001
Nominal luminous flux(lm)	2700 -2900lm
Frequency(Hz)	50/60Hz
Nominal power consumption(W)	30W
Power factor	>0.9
Lumen maintenance factor	L70
Dimmable function	Non-Dimmable / Dimmable
Nominal beam angle(°)	15°/25°/35°
Operating temperature(°C)	-20°C~+48°C
Nominal lamp life time(hrs)	50000hrs
Color temperature(K)	2700K~5000K
CRI(Ra)	>80Ra
Rating	IP 44
Dimension(mm)	Φ110X258mm
Material	Aluminium
Weight(KG)	2.5KG
Energy efficiency index	A++
Energy consumption(kWh/1000h)	30 kWh/1000h
Certification	CE

Dimensional drawing (unit:mm)

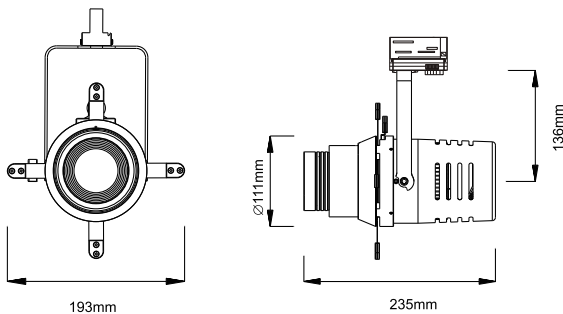

The gobo projector with specially designed lens to gain soft and even light effect from center to edge.

Adjustable focusing range and light brightness enable you to observe the variation of shadow's hardness, dimension and edge contrast.

Precisely control the light and achieve more creative light effects when used in combination with abundant accessories.

The image is clearly visible regardless of the background.

The spotlight blends inconspicuously into the existing spotlights - whether as a track spotlight or as a built-in version.

The graphic is printed on a glass plate. The glass plate with the graphics is very easy to replace.

Aperture slider module equipped. Each aperture can be independently adjusted in position and angle and closes completely. This means that geometric shapes-Trapezoid, square, triangular spot can be created quickly and precisely for targeted lighting or shading of objects and scenarios..



Application

- Advertisements, venues, art galleries and churches, Retail shop and Shopping mall.



LED Outdoor Lighting SDG-001

Beam Angle

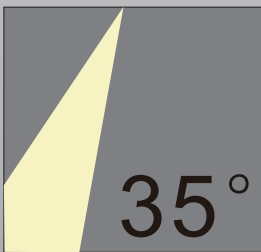
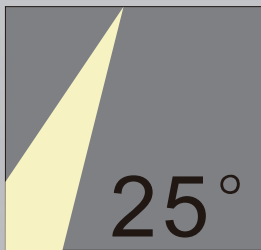
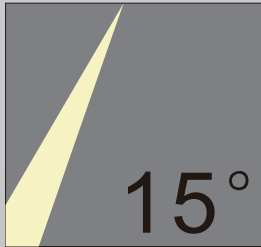

Installation Instruction

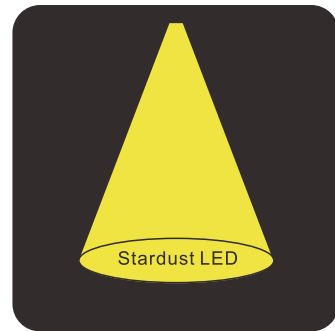

Cut light profile to your desired

Contact

Stardust Lighting Co.,Ltd

+86-757-82226490

+86-757-86408550

postmaster@stardust-lighting.com

www.stardust-lighting.com

Cross of Shangbo, Nanhai Luocun Town, Foshan

China 528226

